

## ESTORES BAMBÚ

### GUÍA DE INSTALACIÓN

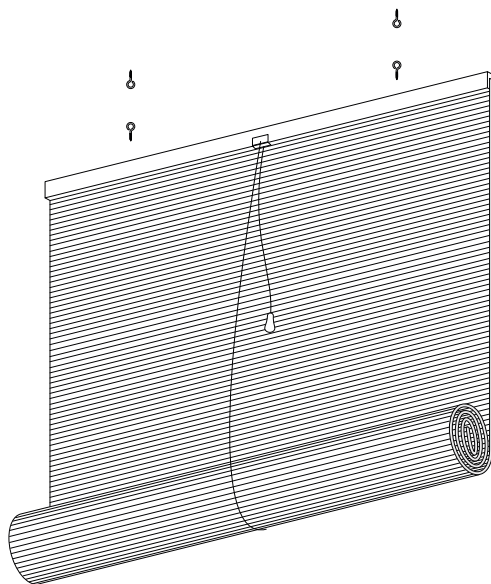

# Comprobamos las piezas

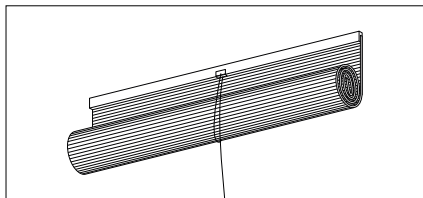

**Estor bambú**

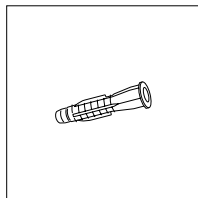

**Tacos\***

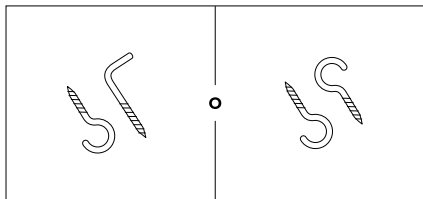

**Ganchos\***  
para pared

**Ganchos\***  
para techo

*\*Si la instalación se va a realizar en alguna superficie que no sea ladrillo, es recomendable adquirir alguna tornillería específica.*

# Necesitamos

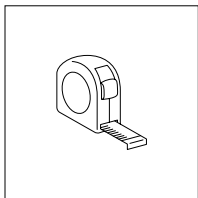

**Cinta métrica**

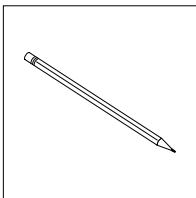

**Lápiz**

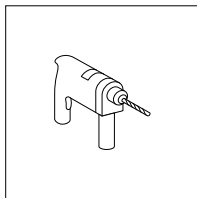

**Taladro**

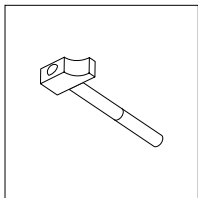

**Martillo**

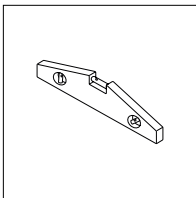

**Nivel**

# 1 | Preparamos el estor

## INSTALACIÓN A PARED

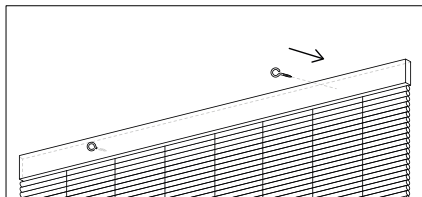

Fijar

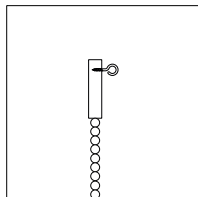

## INSTALACIÓN A TECHO

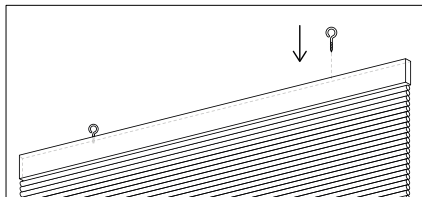

Fijar

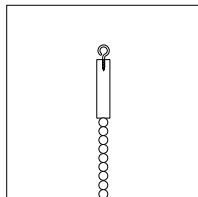

---

**Fijamos** las hembrillas en el estor.

## 2 | Ubicamos las hembrillas

### INSTALACIÓN A PARED

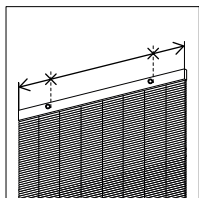

Medir

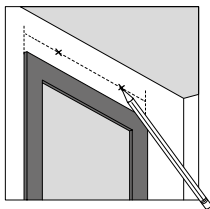

Medir y marcar

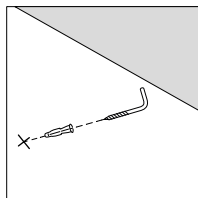

Fijar

### INSTALACIÓN A TECHO

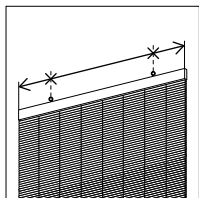

Medir

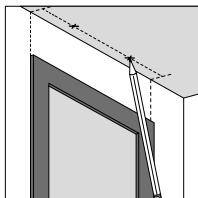

Medir y marcar

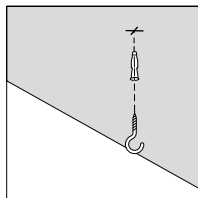

Fijar

---

Con el metro, **medimos** el estor y **ubicamos** las hembrillas que **acabamos** de instalar. **Trasladamos** las medidas a la pared y **marcamos** con un lápiz la ubicación de las hembrillas. **Taladramos**, **colocamos** los tacos y **fijamos** los tornillos.

### 3 | Colocamos el estor

#### INSTALACIÓN A PARED

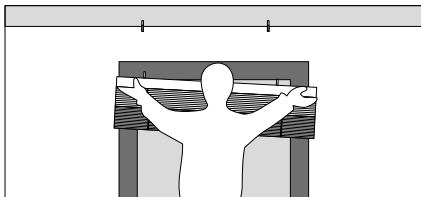

Introducir

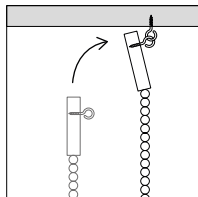

#### INSTALACIÓN A TECHO

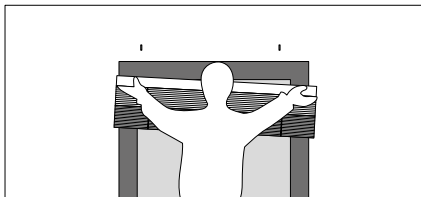

Introducir

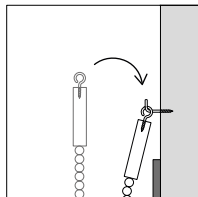

---

**Introducimos** las hembrillas fijado a el estor en los tornillos fijados en la pared o en el techo.

**Atención al cliente**

[soporte@cortinadecor.com](mailto:soporte@cortinadecor.com)

966 181 033

[www.cortinadecor.com](http://www.cortinadecor.com)